



RECYCLING & SCRAPPING
RICICLAGGIO E ROTTAMAZIONE

MRB

RAIL BREAKER
SPACCAROTAIE



**DEMOLITION AND RAIL
SCRAPPING**
DEMOLIZIONE E
RICICLAGGIO ROTAIE



IRON STEEL

FERRO ACCIAIO



SMART BOX

SMART BOX



QUICK
MAINTENANCE

MANUTENZIONE
RAPIDA



INTERCHANGEABLE
TEETH/BLADES

DENTI/LAME
INTERCAMBIABILI



HYDRAULIC
ROTATION

ROTAZIONE
IDRAULICA



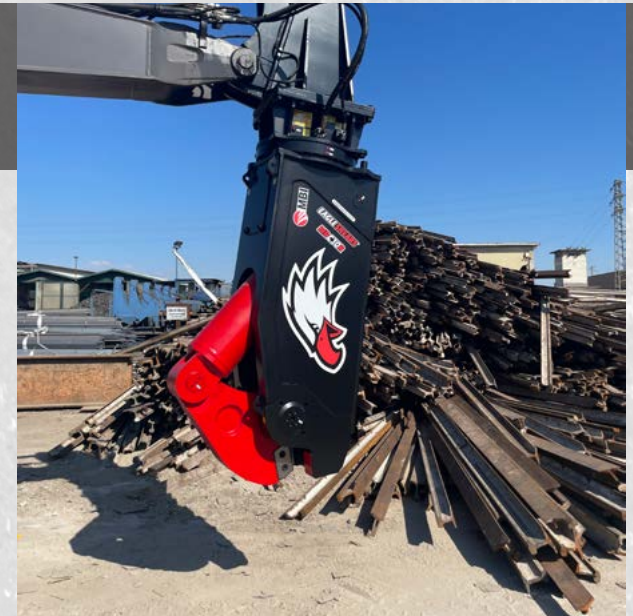

**Rails according to Din EN 13674-41 / **Rotaie secondo standard Din EN 13674-41

MRB

RAIL BREAKER SPACCAROTAIE



MRB30R

ROTATION / ROTAZIONE		360° HYDRAULIC / 360° IDRAULICA	
	t (min-max)	25	35
	lbs	55.115	77.161
	t (min-max)	18	25
	lbs	39.683	55.115
	kg	3.120	
	lbs	6.878	
A	mm	250	
	in	10	
B	mm	190	
	ft/in	7	
C	mm	2.450	
	ft/in	8,0	
	bar	300	320
	psi	4.351	4.641
	l/min	250	300
	gpm	66	79

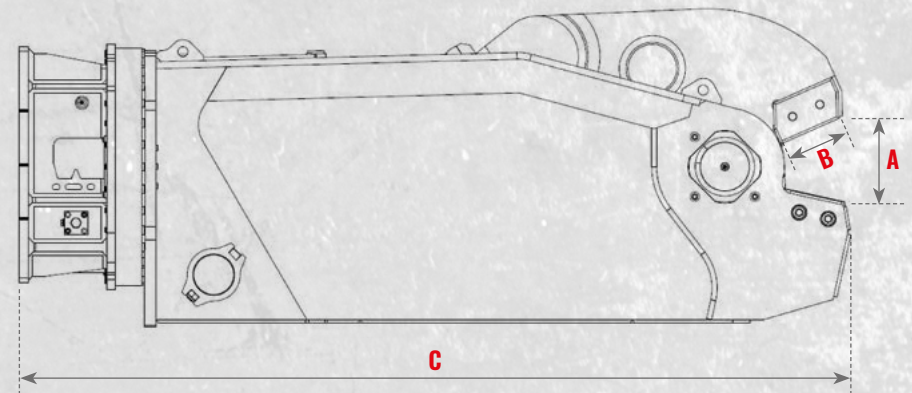

*with bolted bracket (3rd member) / *con sella imbullonata (posto benna)



EXCAVATOR WEIGHT 2nd MEMBER
PESO ESCAVATORE POSTO BRACCIO



EXCAVATOR WEIGHT 3rd MEMBER
PESO ESCAVATORE POSTO BENNA



WEIGHT
PESO



WORKING PRESSURE
PRESSIONE DI ESERCIZIO



OIL FLOW
PORTATA OLIO